

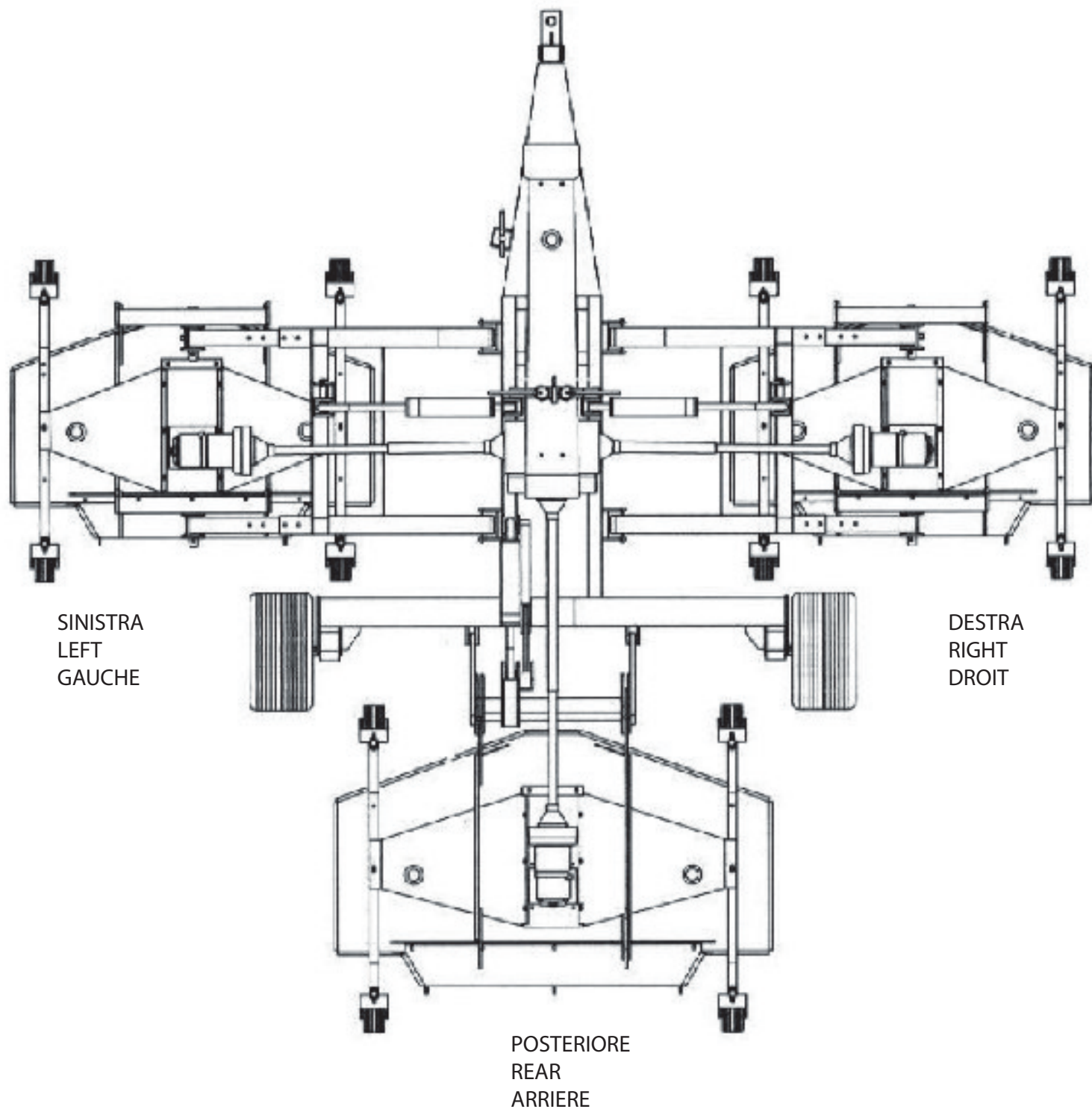

# OMEGA

11 - 12 - 14 - 15 - 17 - 19 - 21

Tagliaerba di finitura  
Finishing Mower  
Tondeuse de Finition





11 - 12 - 14 - 15 - 17 - 19 - 21

# OMEGA

Tagliarba di finitura  
Finishing Mower  
Tondeuse de Finition

TRASMISSIONE - DRIVE TRAIN COMPONENTS - TRANSMISSION

SINISTRO  
LEFT  
GAUCHE

OMEGA 11	42600088
OMEGA 12	42600039
OMEGA 14	42600076
OMEGA 15	42600040
OMEGA 17	42600041
OMEGA 19	42600042
OMEGA 21	42600099

42400001
□M321D
40200011
42400001
40300009
40100025

42600031

42600023  
42000018

DESTRO  
RIGHT  
DROIT

OMEGA 11	42600088
OMEGA 12	42600039
OMEGA 14	42600076
OMEGA 15	42600040
OMEGA 17	42600041
OMEGA 19	42600042
OMEGA 21	42600099

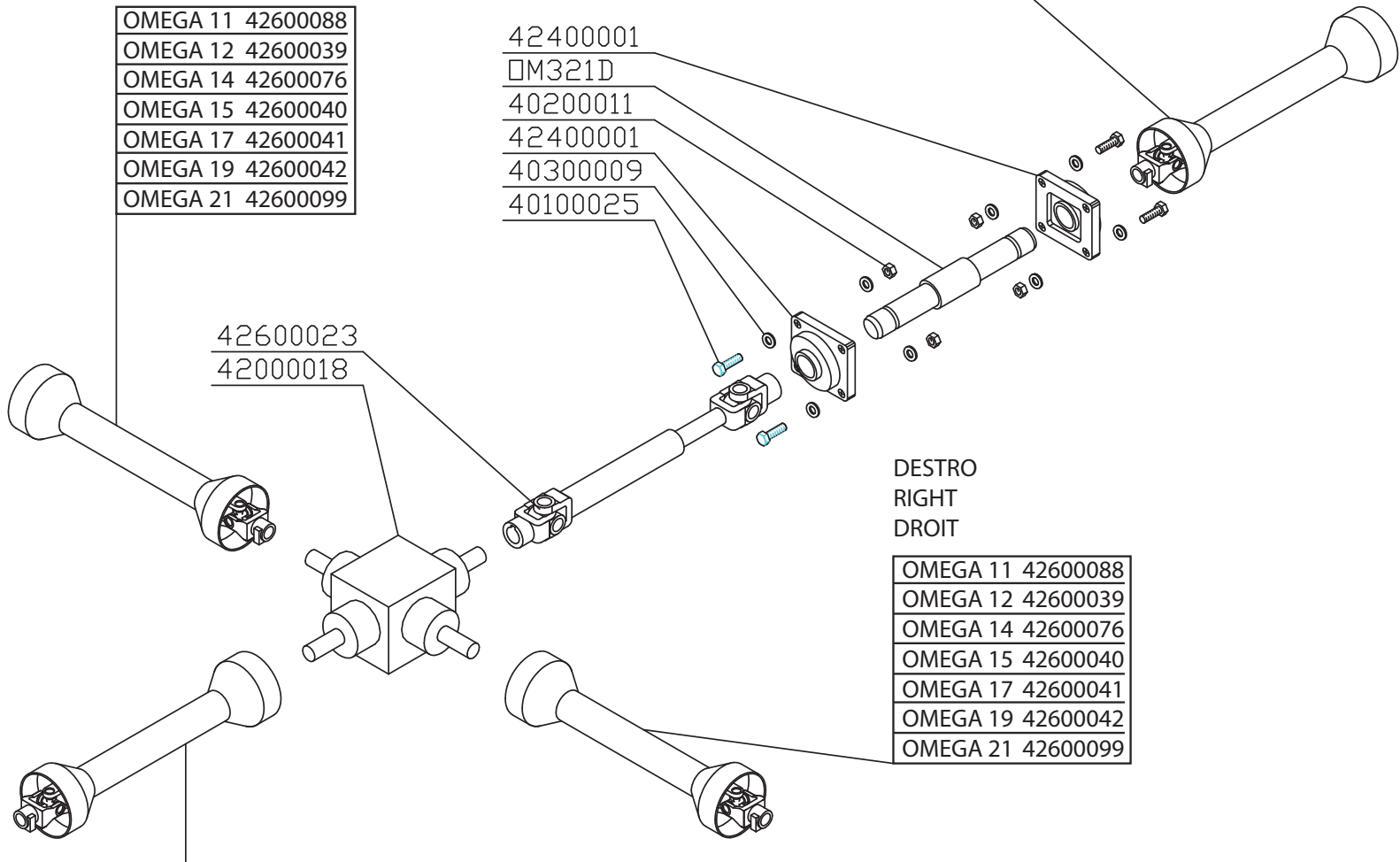

118

POSTERIORE	RUOTE - WHEELS - ROUES	OMEGA 11-12-14-15-17	OMEGA 19-21
REAR	Ø 210 mm	42600041	42600040
ARRIERE	Ø 310/330 mm	42600099	42600042



# OMEGA

11 - 12 - 14 - 15 - 17 - 19 - 21

Tagliaerba di finitura  
Finishing Mower  
Tondeuse de Finition

## TELAIO CENTRALE - CENTRAL FRAME - CHASSIS CENTRAL

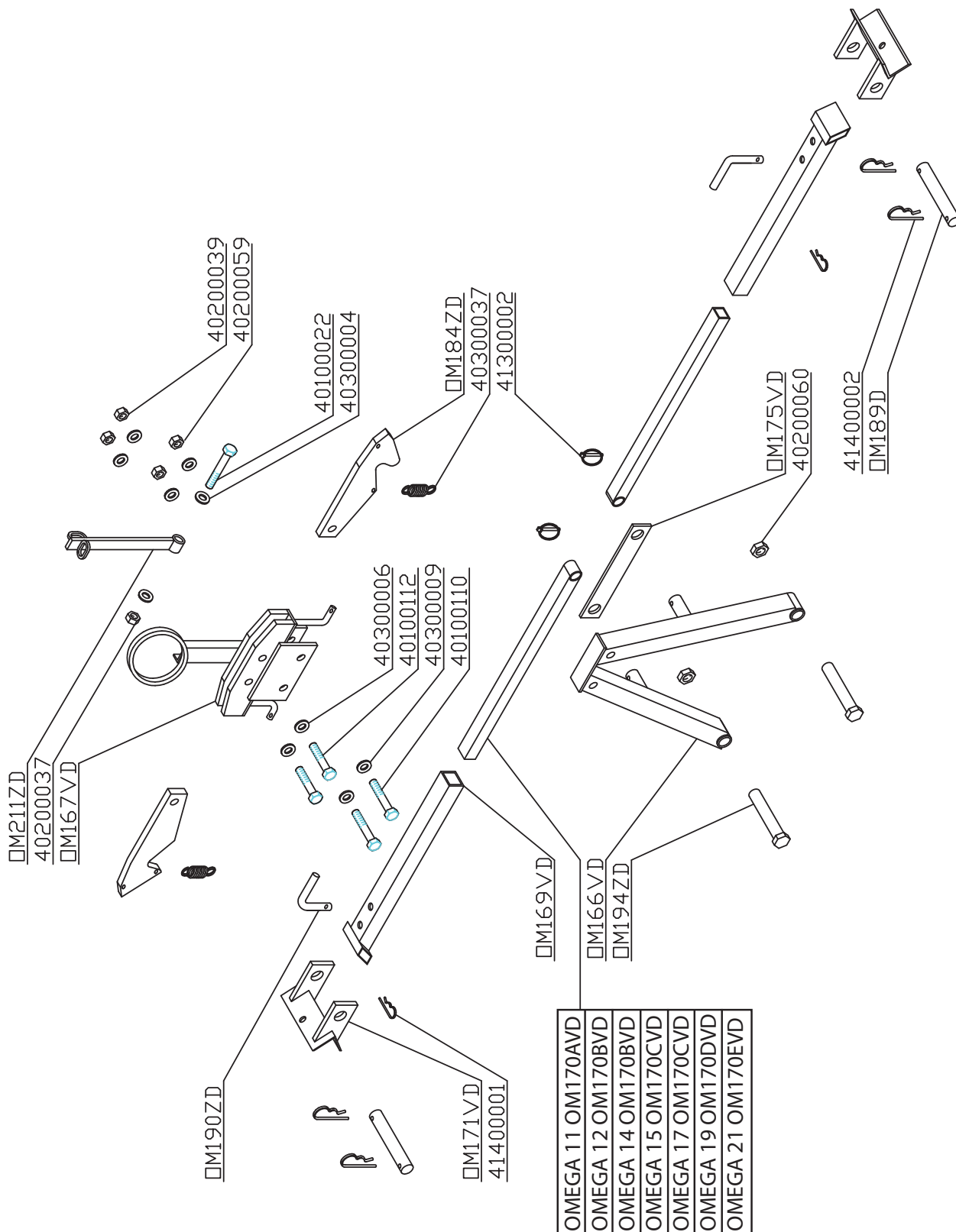



# OMEGA

11 - 12 - 14 - 15 - 17 - 19 - 21

Tagliaerba di finitura  
Finishing Mower  
Tondeuse de Finition

## TELAIO DESTRO - RIGHT FRAME - CHASSIS DROIT

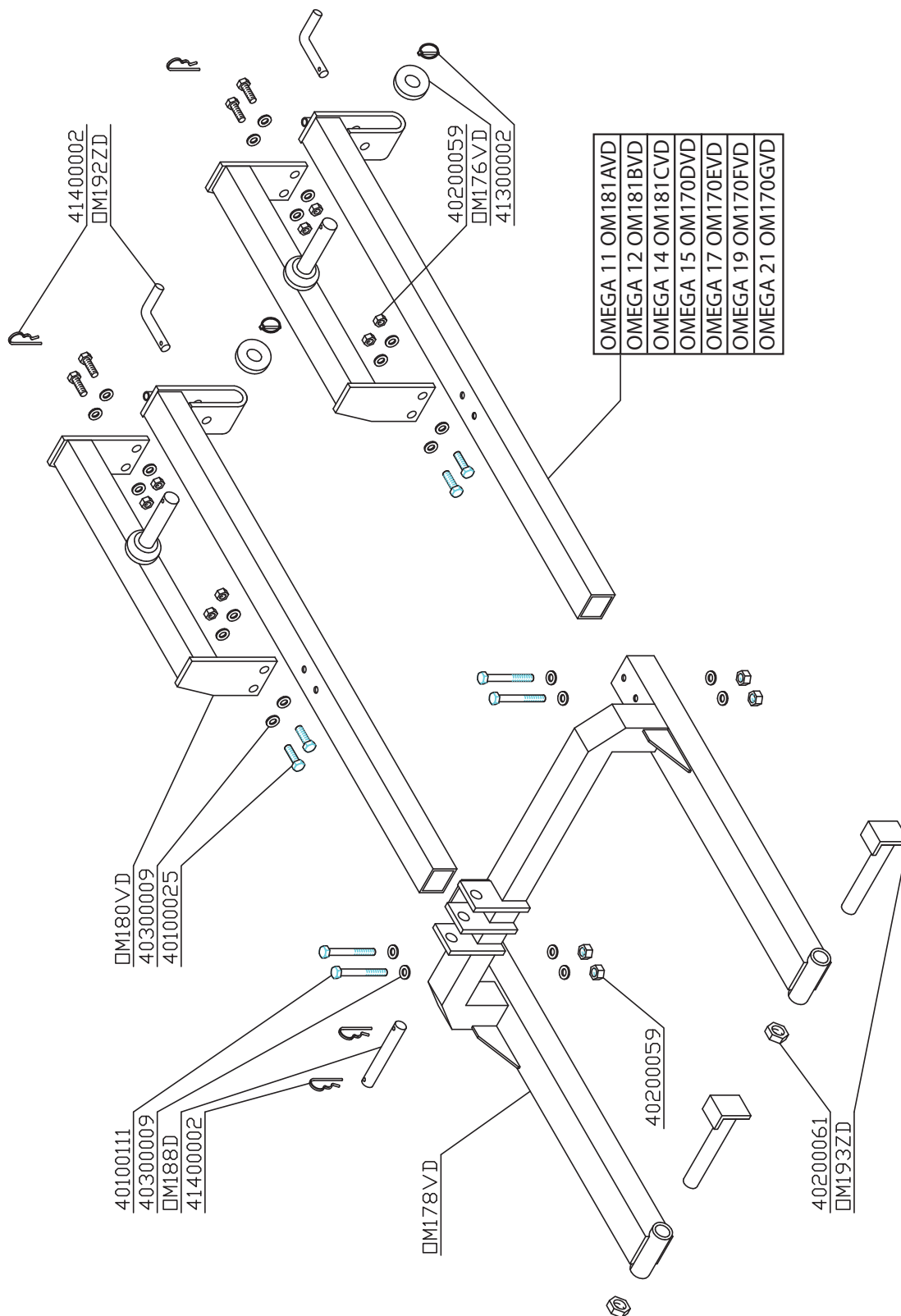



# OMEGA

11 - 12 - 14 - 15 - 17 - 19 - 21

Tagliaerba di finitura  
Finishing Mower  
Tondeuse de Finition

## TELAIO POSTERIORE - REAR FRAME - CHASSIS ARRIERE

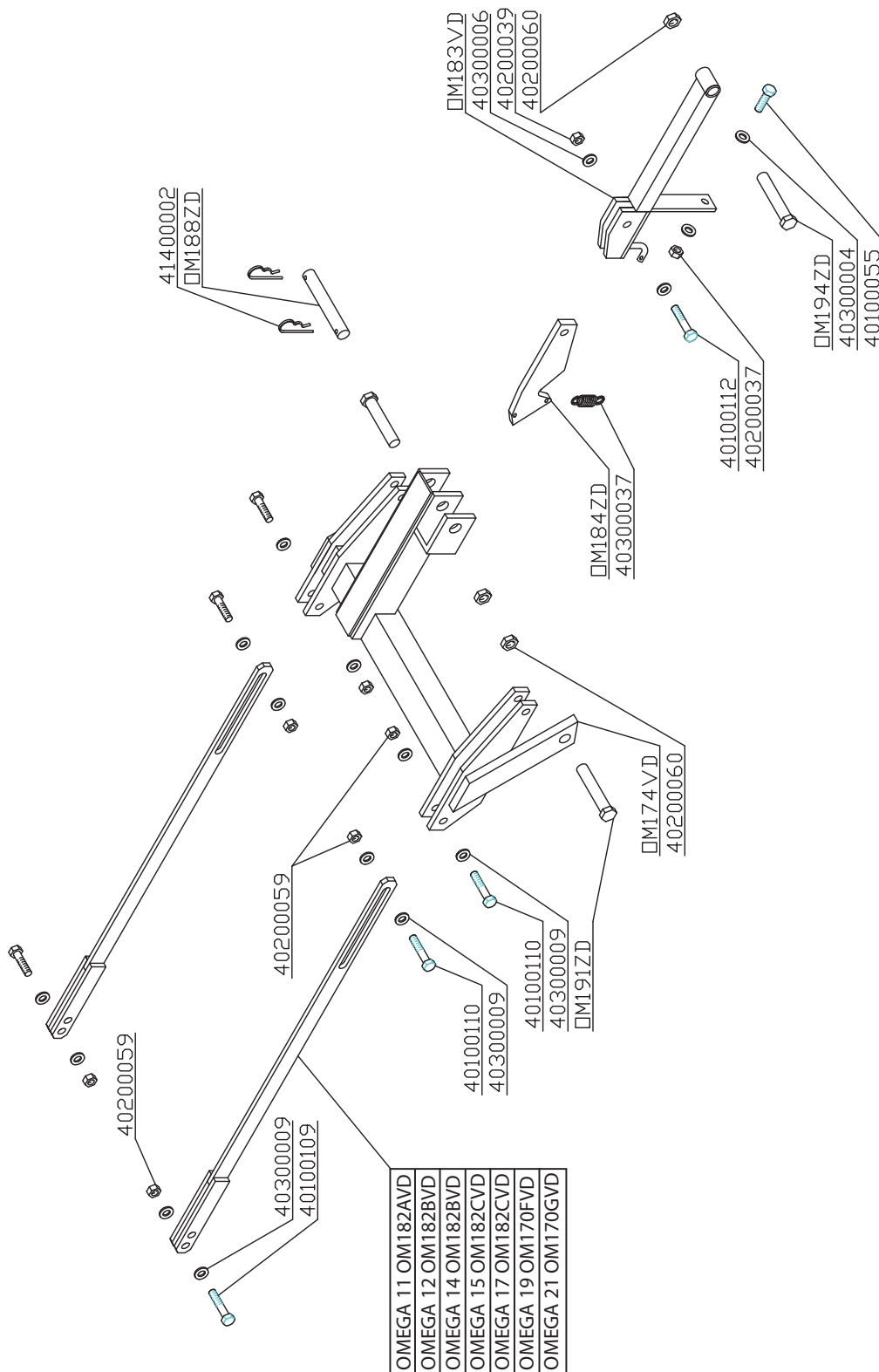



# OMEGA

11 - 12 - 14 - 15 - 17 - 19 - 21

Tagliaerba di finitura  
Finishing Mower  
Tondeuse de Finition

## TELAIO SINISTRO - LEFT FRAME - CHASSIS GAUCHE

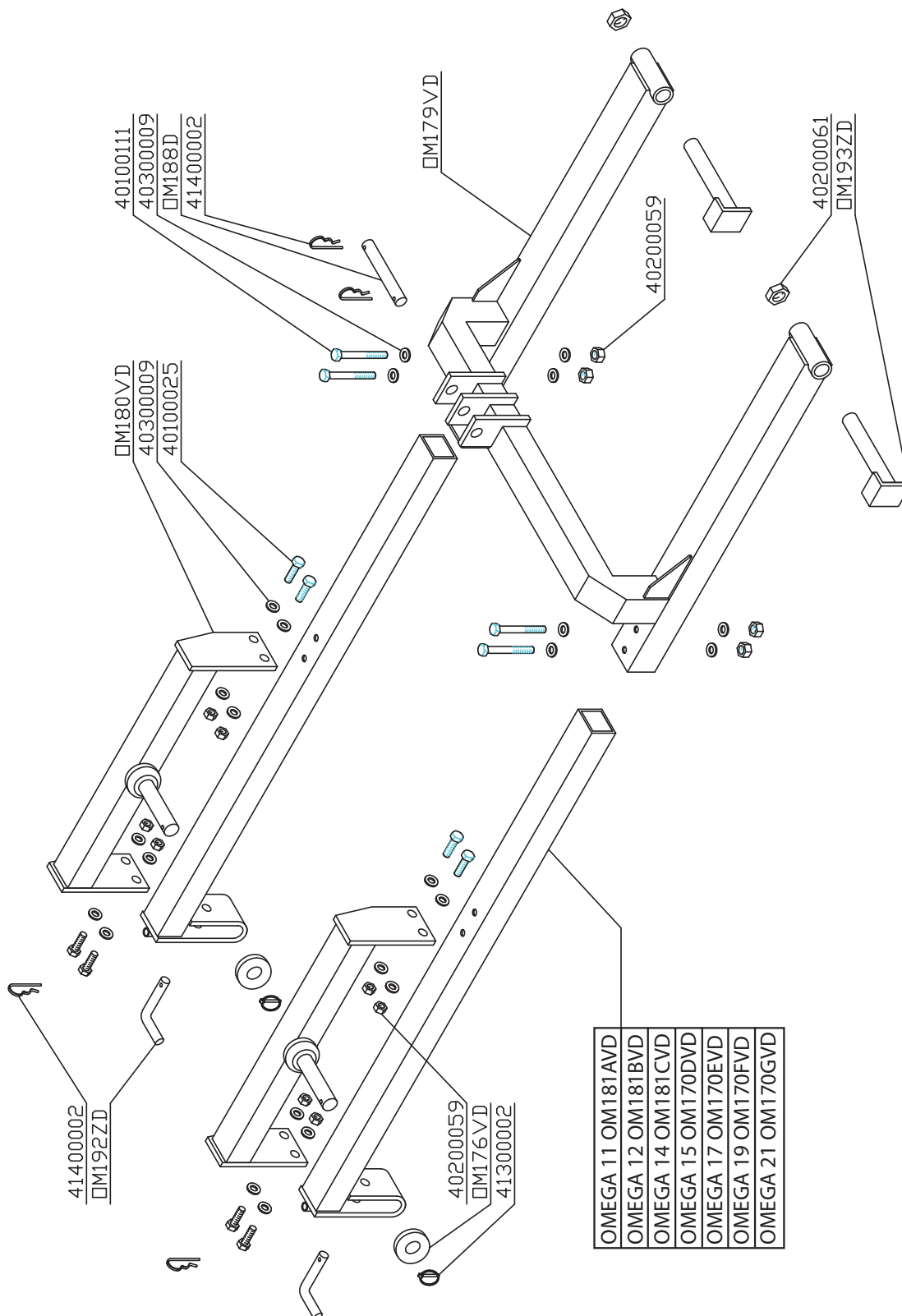



# OMEGA

11 - 12 - 14 - 15 - 17 - 19 - 21

Tagliaerba di finitura  
Finishing Mower  
Tondeuse de Finition

## TELAIO PORTANTE - MAIN FRAME - CHASSIS PRINCIPAL

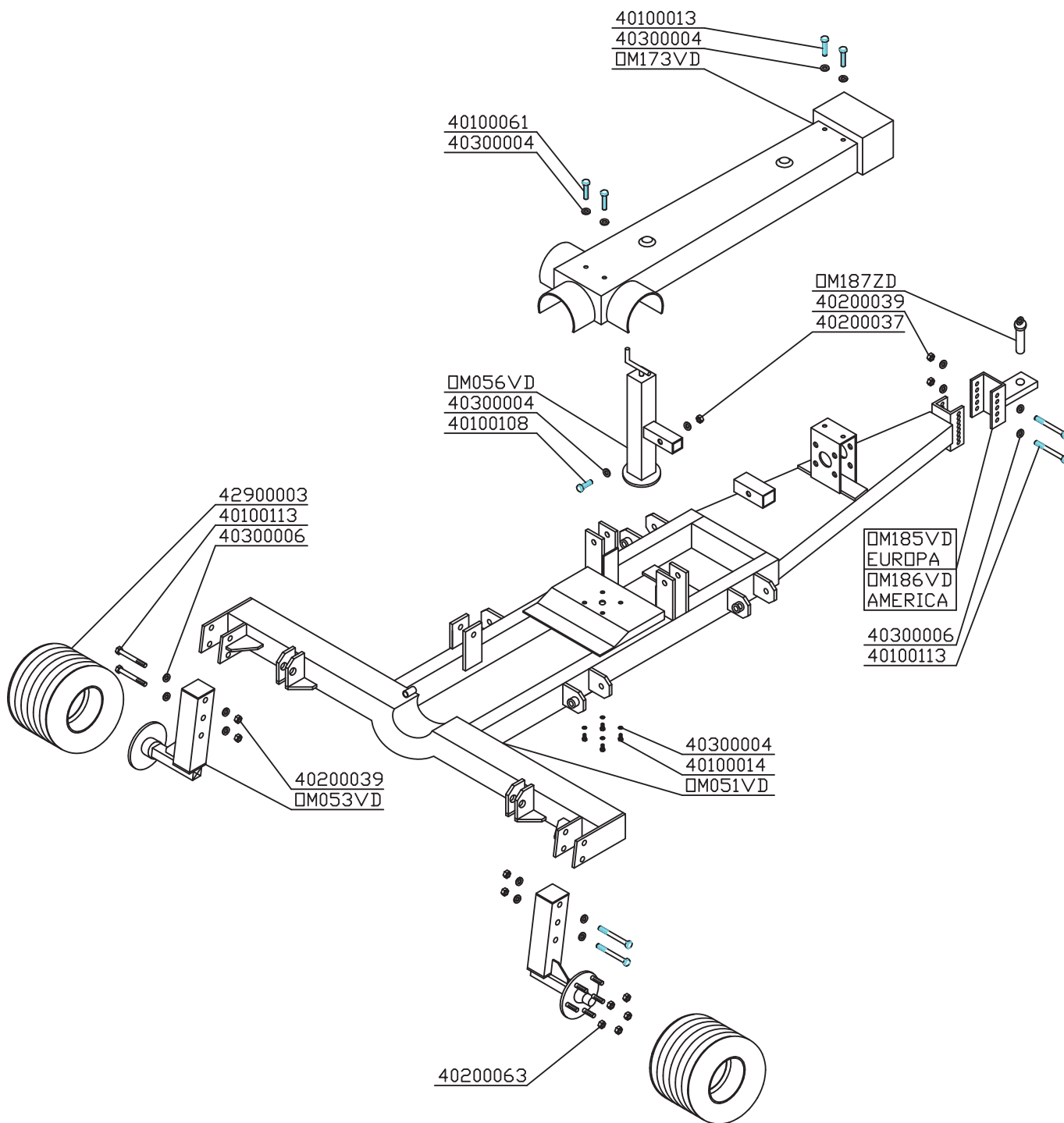



# OMEGA

11 - 12 - 14 - 15 - 17 - 19 - 21

Tagliaerba di finitura  
Finishing Mower  
Tondeuse de Finition

## IMPIANTO IDRAULICO - HYDRAULIC PLANT - CIRCUIT HYDRAULIQUE

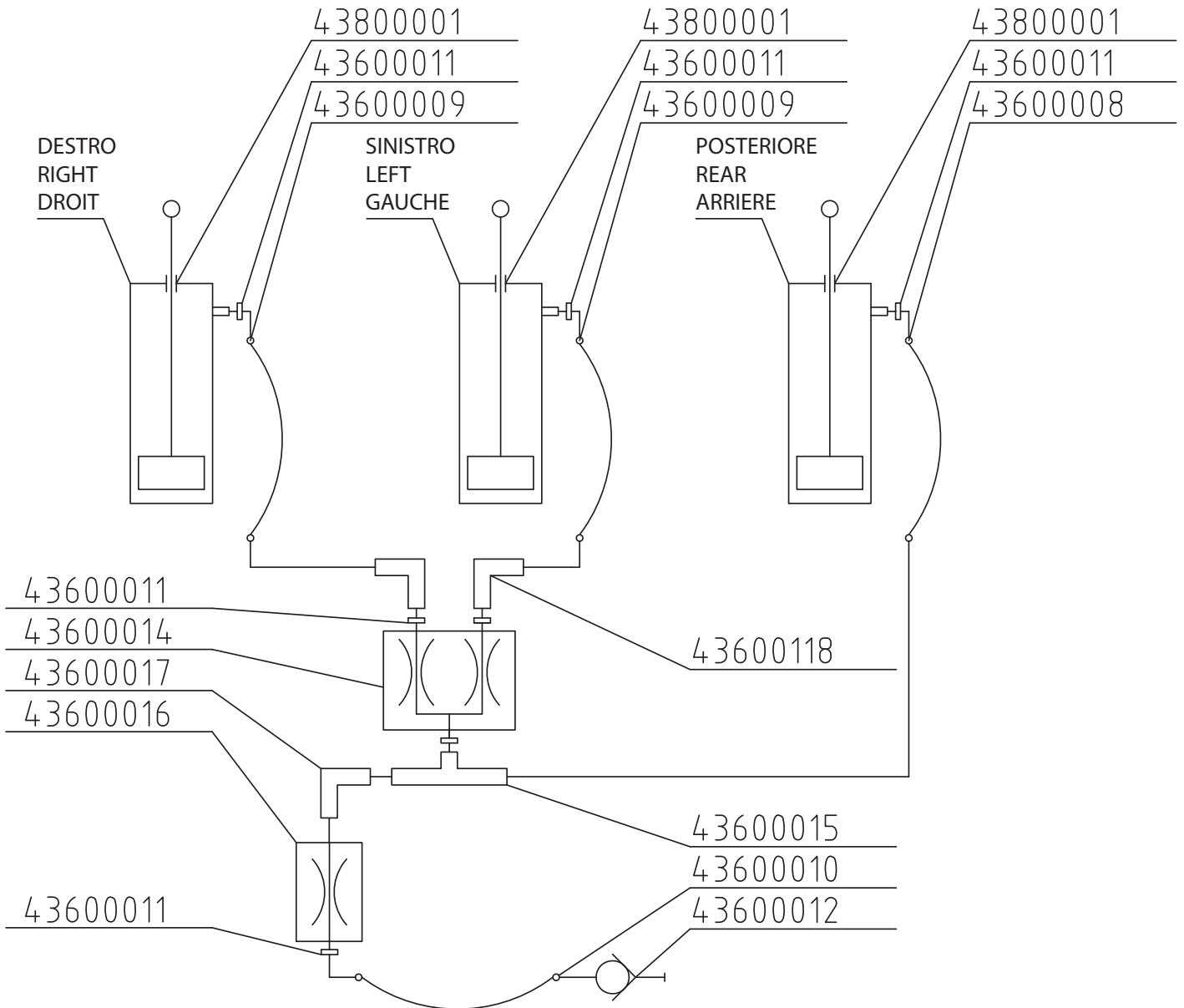





# OMEGA

11 - 12 - 14 - 15 - 17 - 19 - 21

Tagliaerba di finitura  
Finishing Mower  
Tondeuse de Finition

## LUBRIFICAZIONE CENTRALIZZATA - CENTRALIZED LUBRICATION - LUBRIFICATION CENTRALISEE

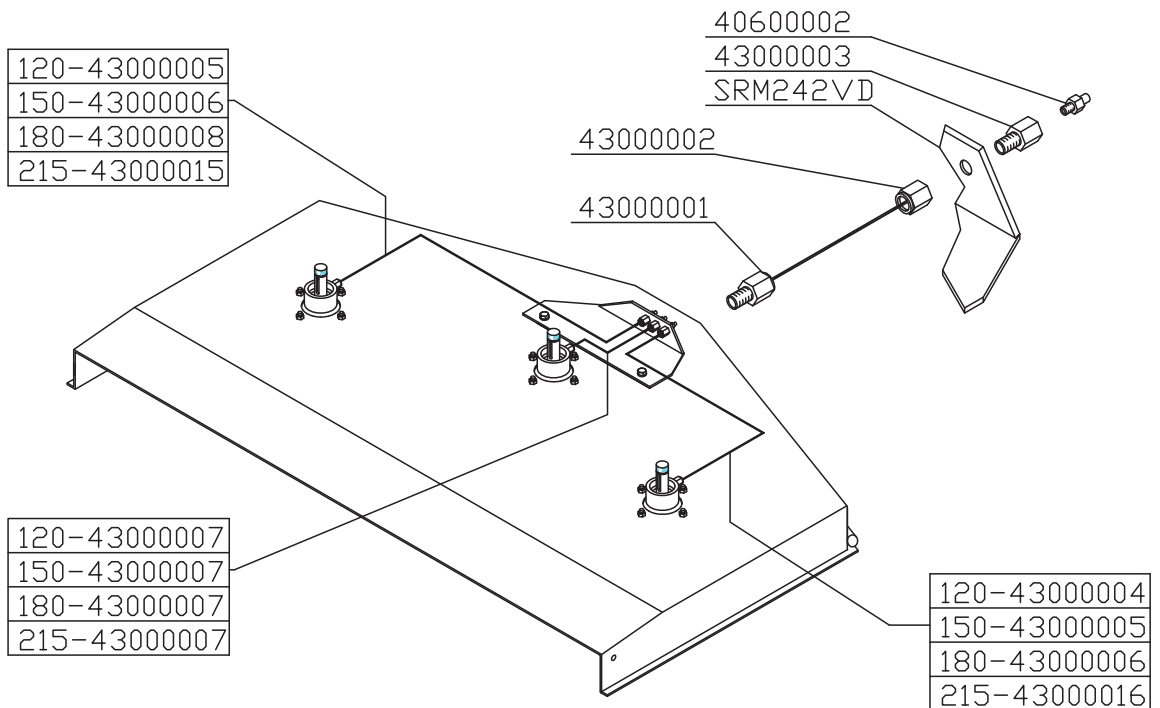
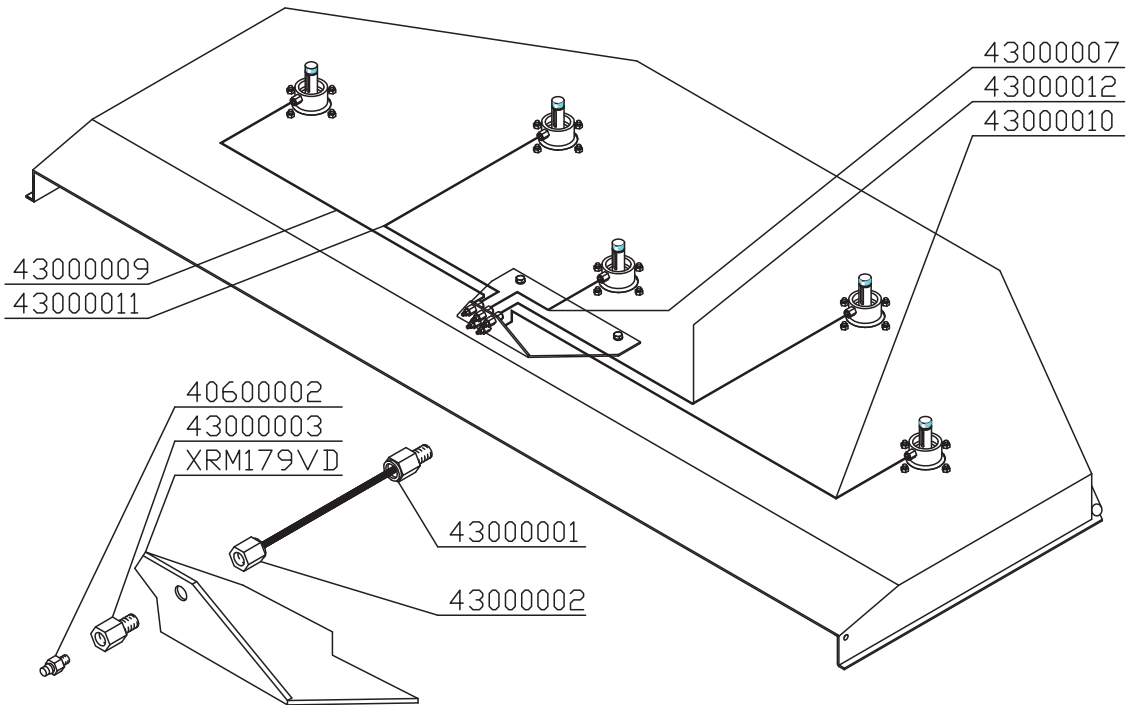



# OMEGA

11 - 12 - 14 - 15 - 17 - 19 - 21

Tagliaerba di finitura  
Finishing Mower  
Tondeuse de Finition

## TRASMISSIONE - DRIVE TRAIN COMPONENTS - TRANSMISSION (PRM 120 - 150 - 180 - 215)

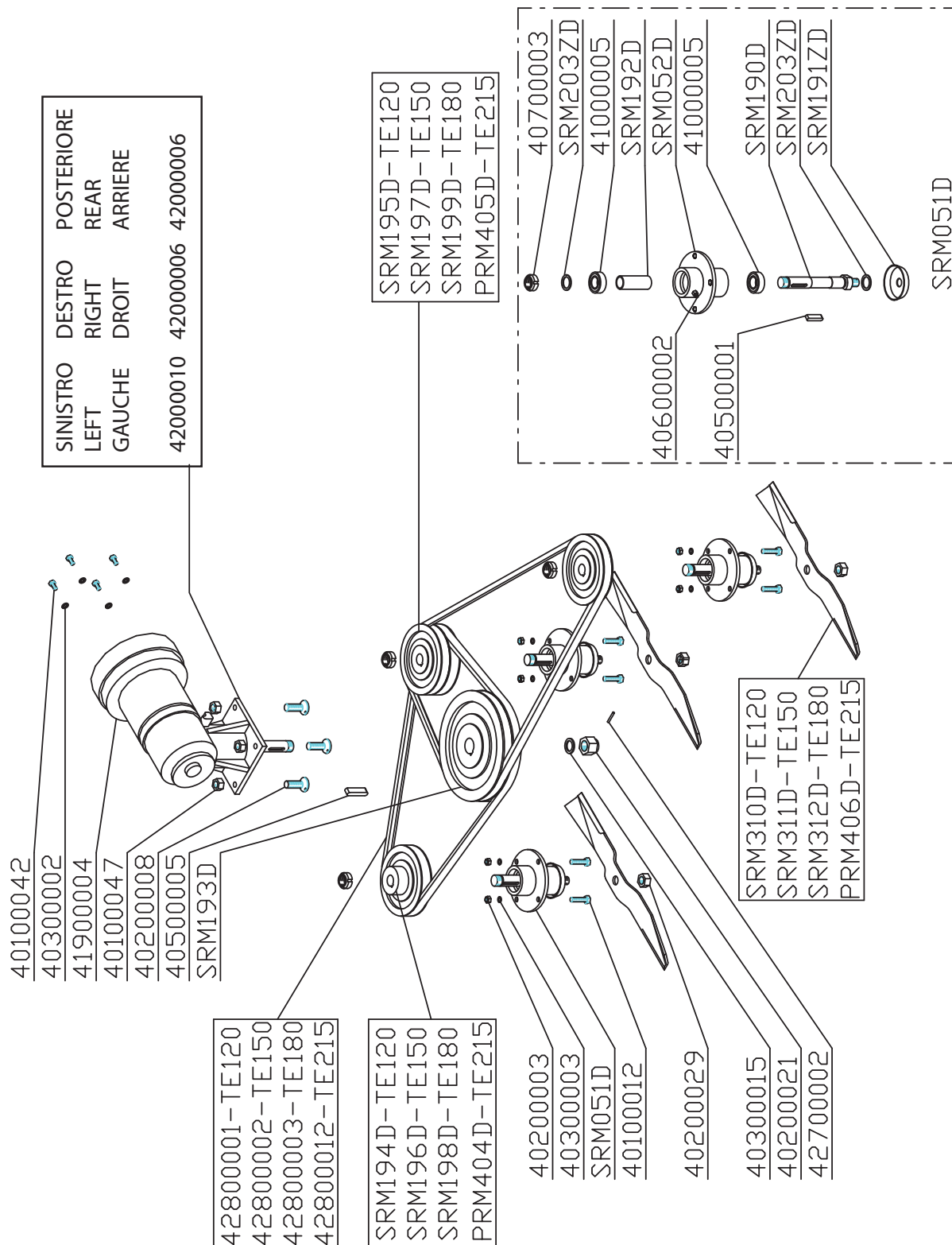



# OMEGA

11 - 12 - 14 - 15 - 17 - 19 - 21

Tagliaerba di finitura  
Finishing Mower  
Tondeuse de Finition

## TRASMISSIONE - DRIVE TRAIN COMPONENTS - TRANSMISSION (XRM 235)

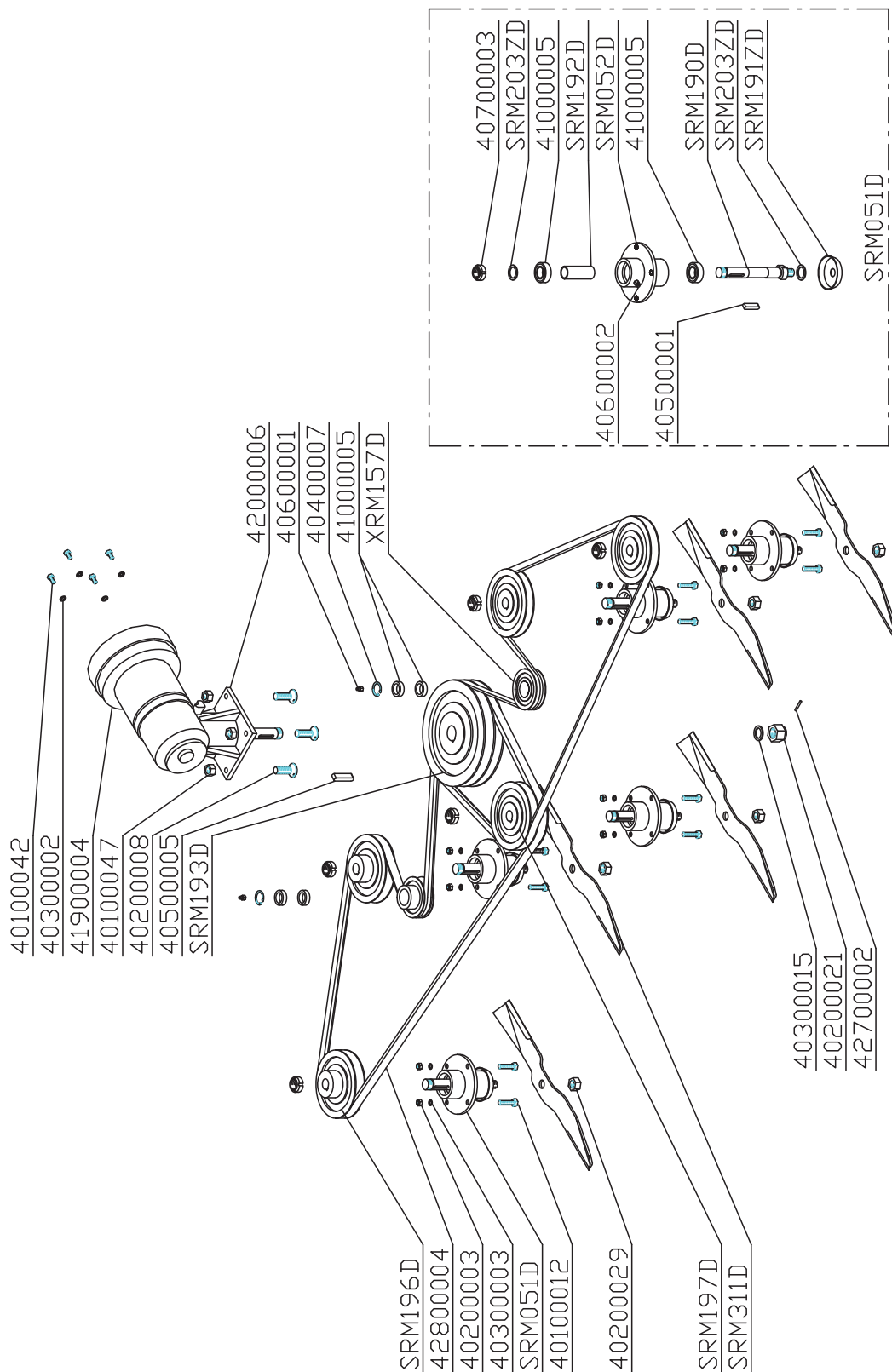



# OMEGA

11 - 12 - 14 - 15 - 17 - 19 - 21

Tagliaerba di finitura  
Finishing Mower  
Tondeuse de Finition

## TELAIO - FRAME - CHASSIS (PRM 120 - 150 - 180 - 215)

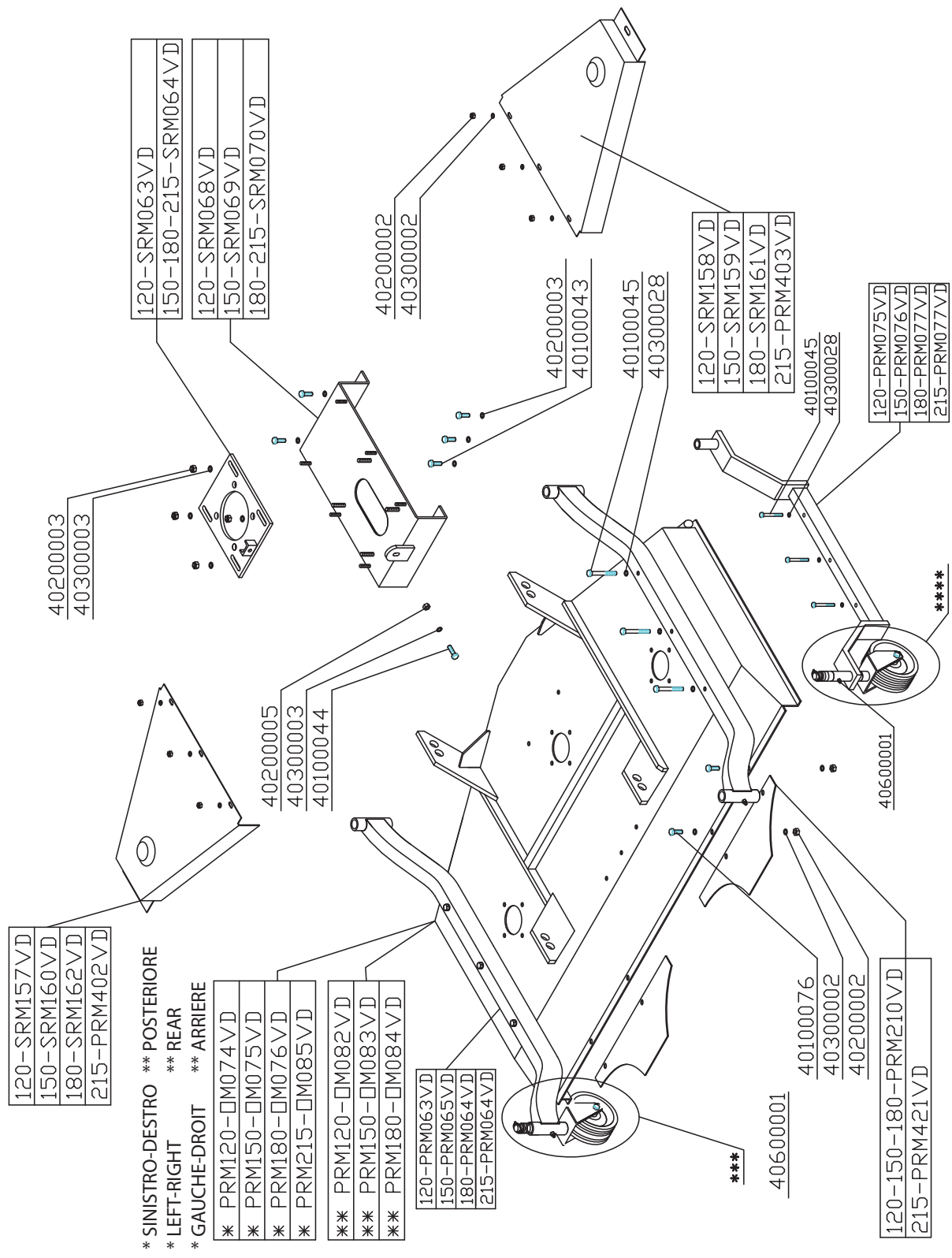



# OMEGA

11 - 12 - 14 - 15 - 17 - 19 - 21

Tagliaerba di finitura  
Finishing Mower  
Tondeuse de Finition

## TELAIO - FRAME - CHASSIS (XRM 235)

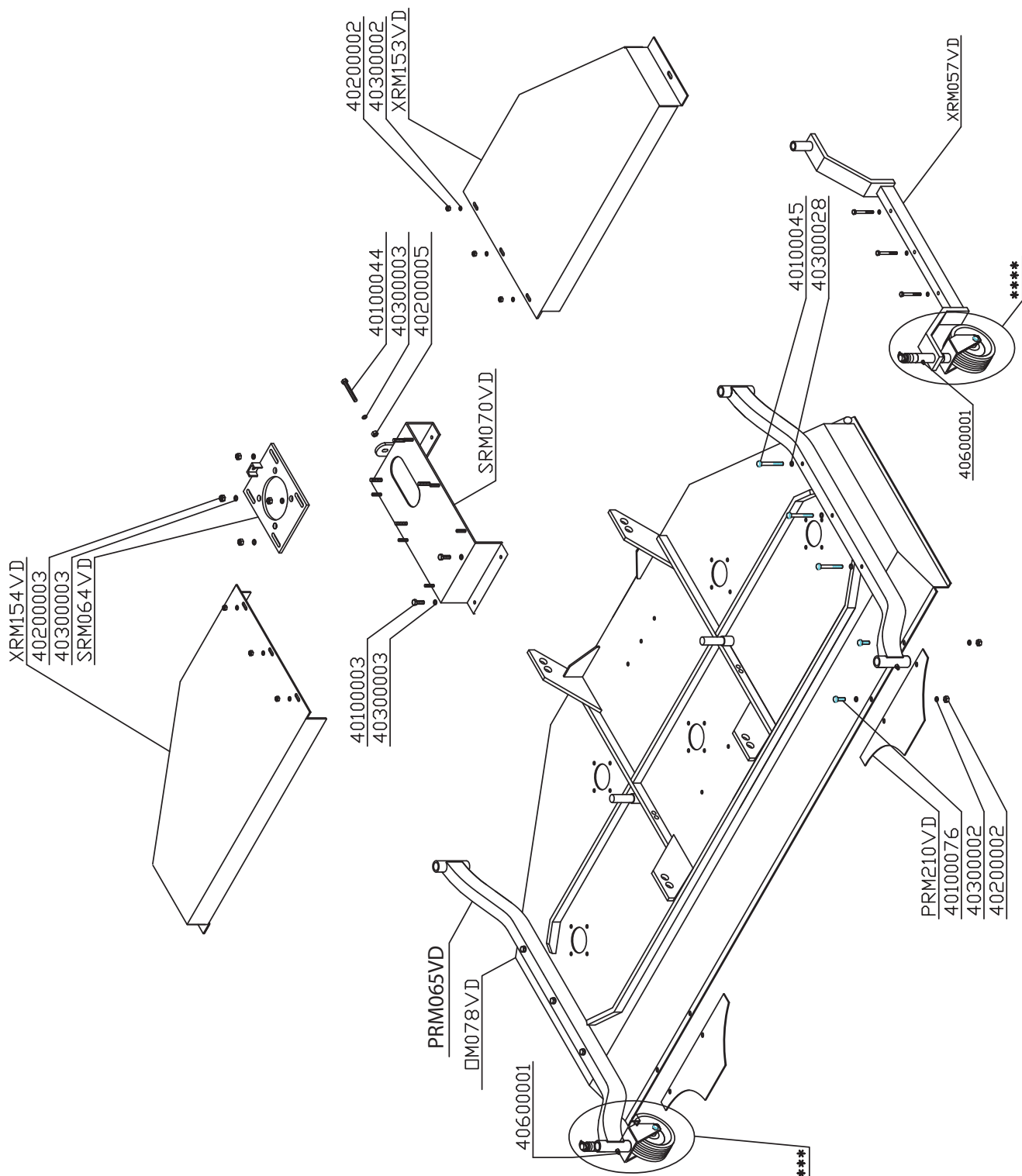



# OMEGA

11 - 12 - 14 - 15 - 17 - 19 - 21

Tagliaerba di finitura  
Finishing Mower  
Tondeuse de Finition

## RUOTE - WHEELS - ROUES

